



International Interdisciplinary Conference on
Land Use and Water Quality
Agricultural Production and the Environment
Vienna, Austria, 21-24 September 2015

GLM Analyses of field and large laboratory experiments and their use to calibrate surface phosphorus load model for the watershed of Lake Balaton

István SISÁK

University of Pannonia Georgikon Faculty
16 Deák F. st., H-8360 Keszthely, Hungary
talajtan@georgikon.hu

Location of Hungary within Europe and location of the watershed of Lake Balaton in Hungary

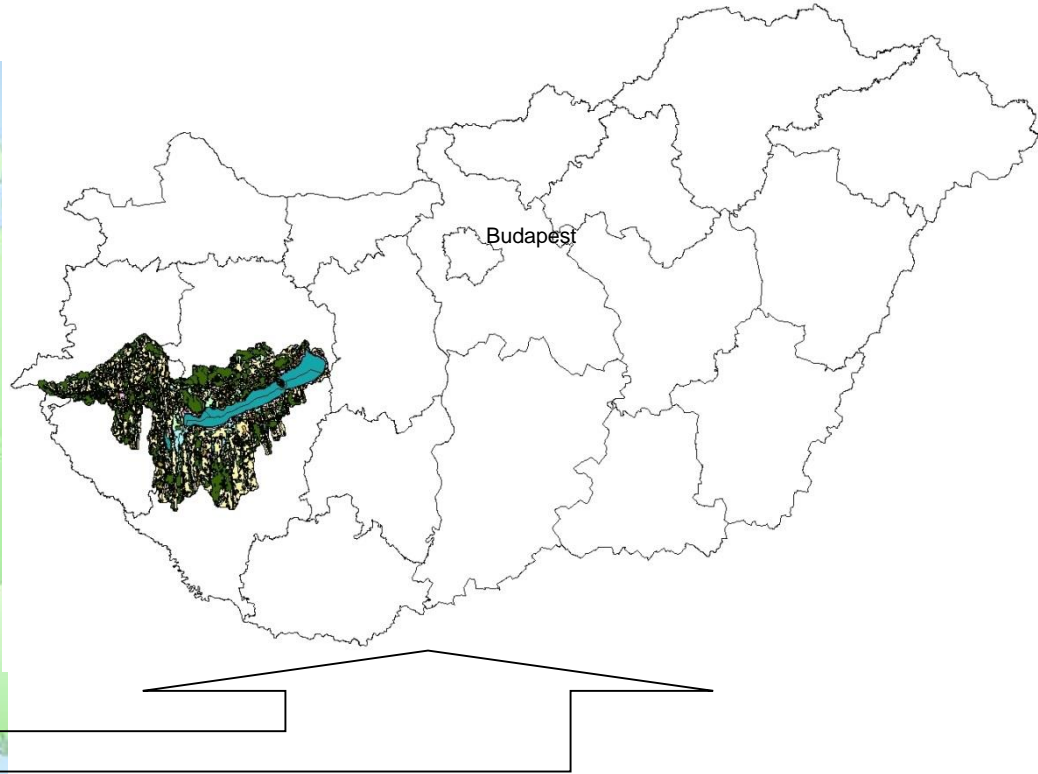

The only major watershed completely within the borders
The 2nd most important touristic area in Hungary

Problem statement

WATERSHED

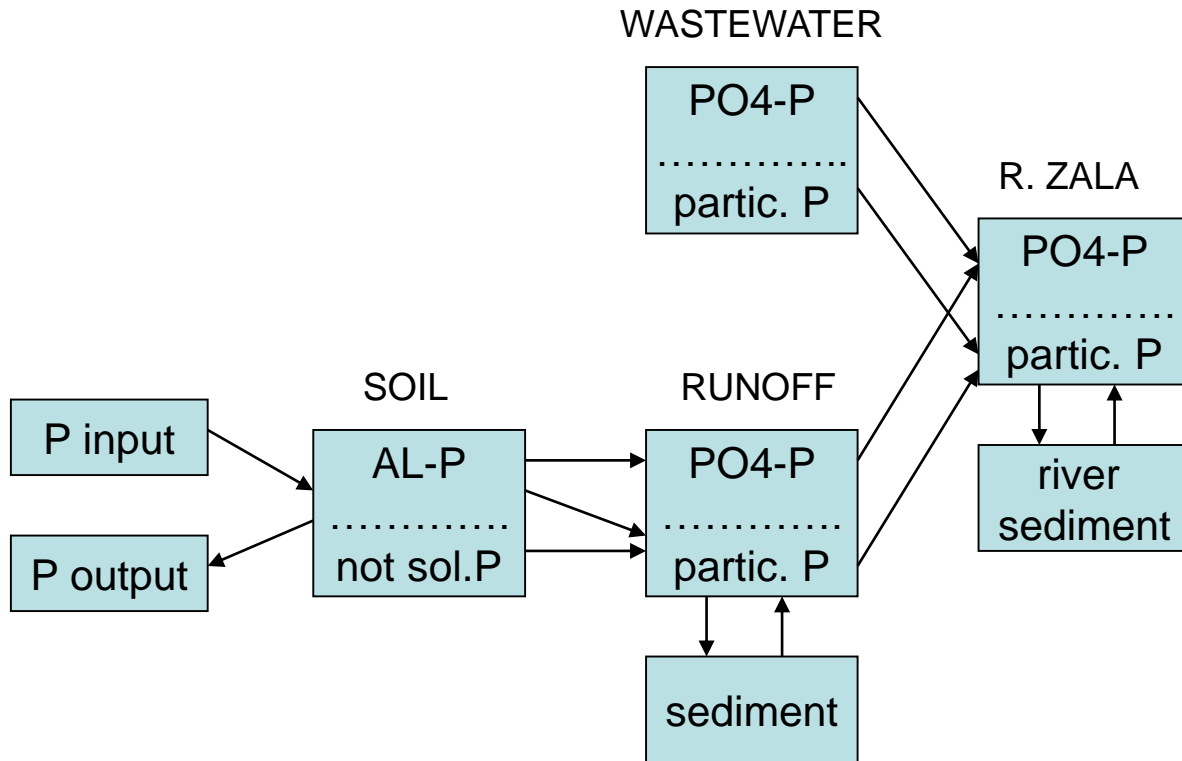



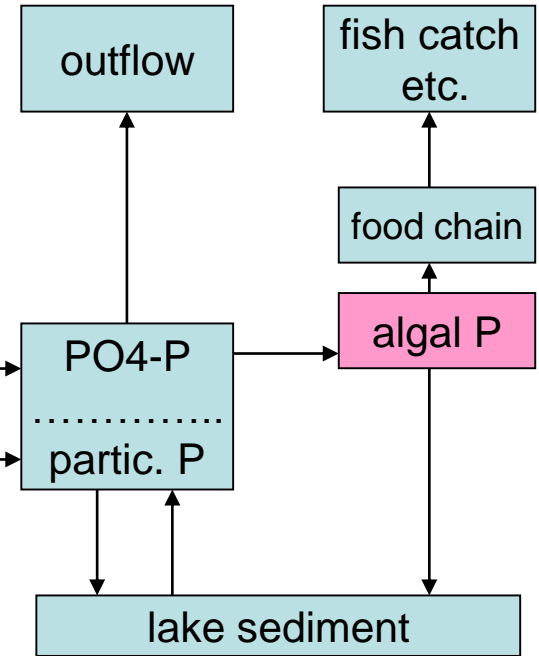

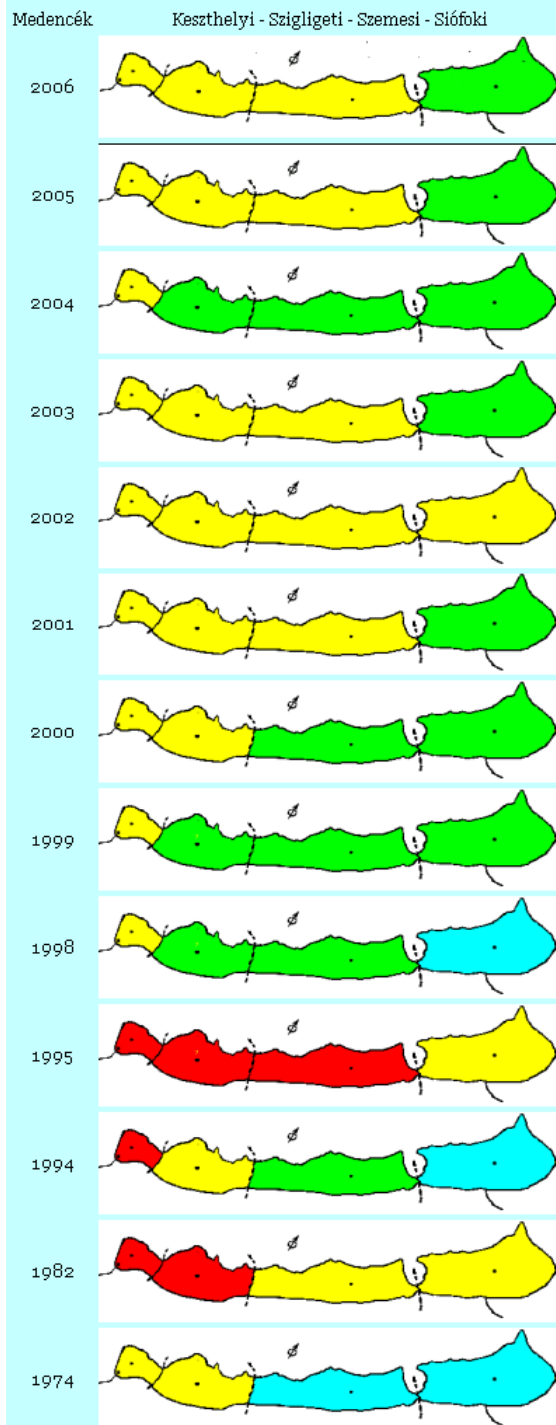
LAKE BALATON





Deterioration of the water started in the late 1960's
 Macrophyton eutrophication → algae blooms
 Worst year: 1995

OECD szerinti minősítés

	Oligotróf	<8 µg/l
	Mezotróf	8-25 µg/l
	Eutróf	25-75 µg/l
	Hipertróf	>75 µg/l

Az ábrásor összeállításánál a nyári időszakban a **nyílt vízben mért** klorofill-a értékeket vettük figyelembe.

A tó vízminősége nyugatról keletre fokozatosan változik, a keleti medencében kedvezőbb minőséget mutatva. A vízminőség különbségét a medencénként eltérő - időnként előforduló - algásodás is jelzi.

A tó vízminőségét egyre csökkenő mértékben ugyan, de kedvezőtlenül befolyásolja, a Zala vízgyűjtőről érkező növényi tápanyag, amely a Kís-Balatonból távozva a tó összes terhelésének több, mint egyharmada.

Oligotrophic
 Mesotrophic
 Eutrophic
 Hypertrophic

Main reason: external phosphorus load
 (point sources and non-point sources)

Main possibility of regulation: reducing external P load

Site description and prevention measures
There are still problems remaining

WATERSHED

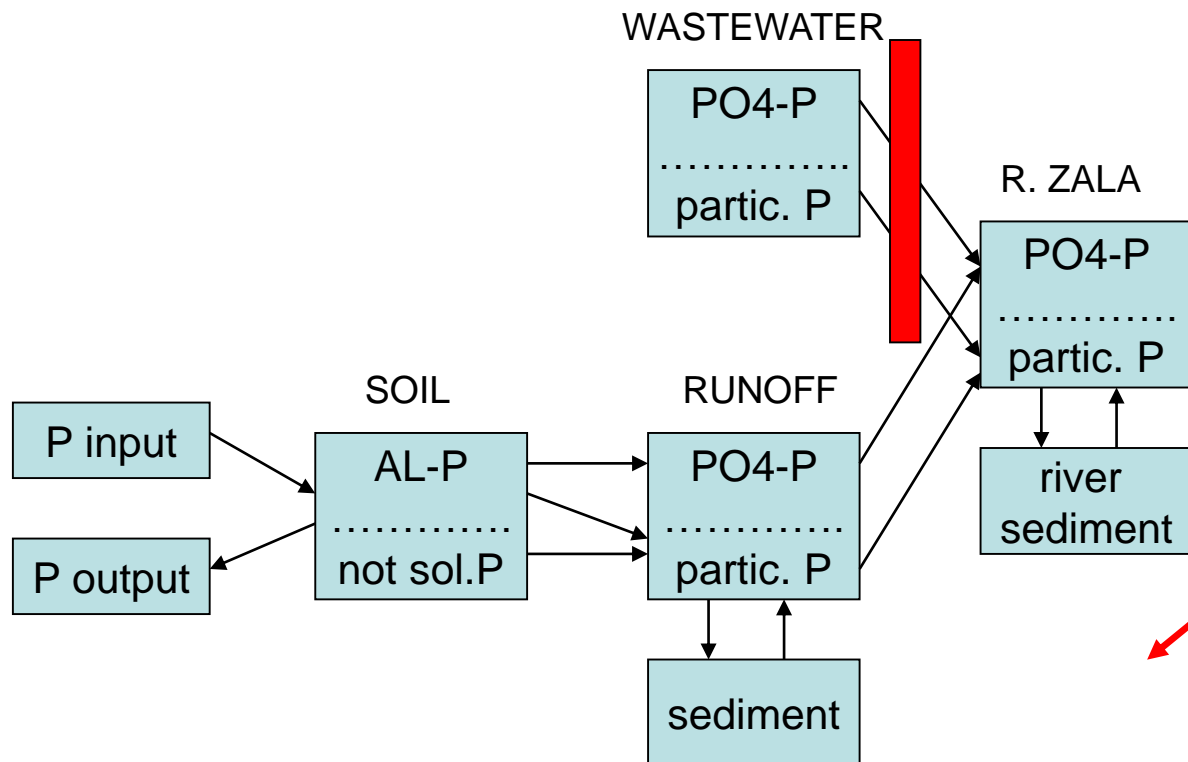

LAKE BALATON

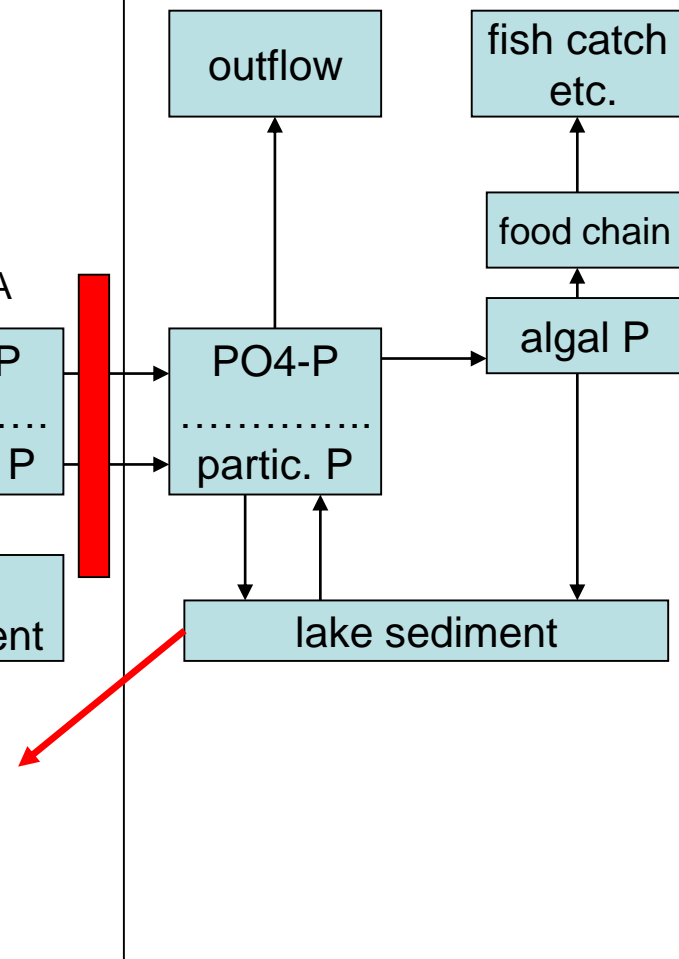

Land use in the watershed of Lake Balaton (Corine Landcover Database 2000)

The lake

80 km long
8 km wide
660 km² large
3.4 m deep
2 km³ volume

The watershed

5200 km²
2600 km² River Zala (West)

Legend

	towns, dwellings
	arable land
	vineyards, orchards
	pasture, greenland
	woodland, forest
	wetland
	lake, reservoirs

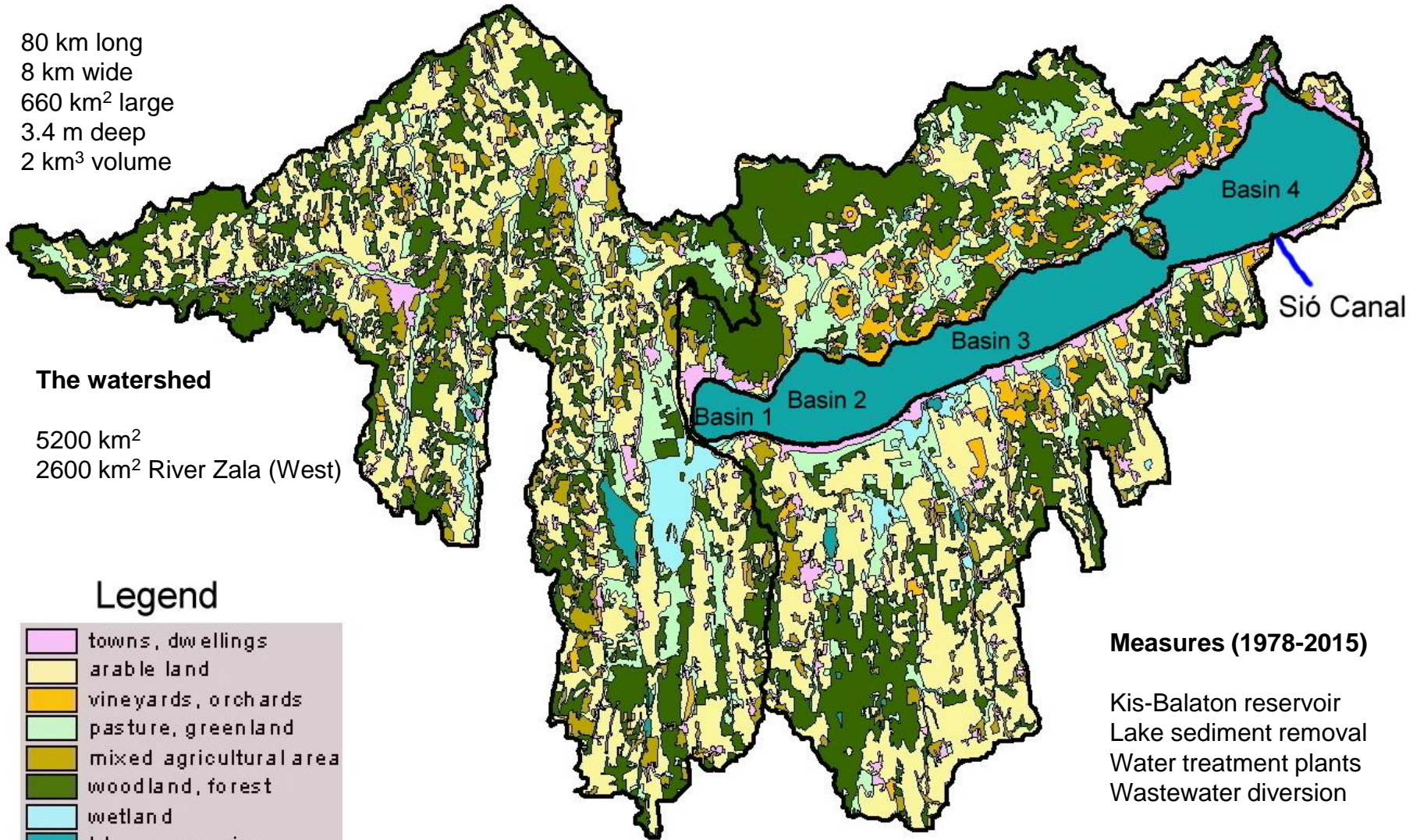

Measures (1978-2015)

Kis-Balaton reservoir
Lake sediment removal
Water treatment plants
Wastewater diversion

The problem still exist: the western basins are hypertrophic at lakeshore

Hypothesis: water quality cannot be further improved without agri-environmental measures

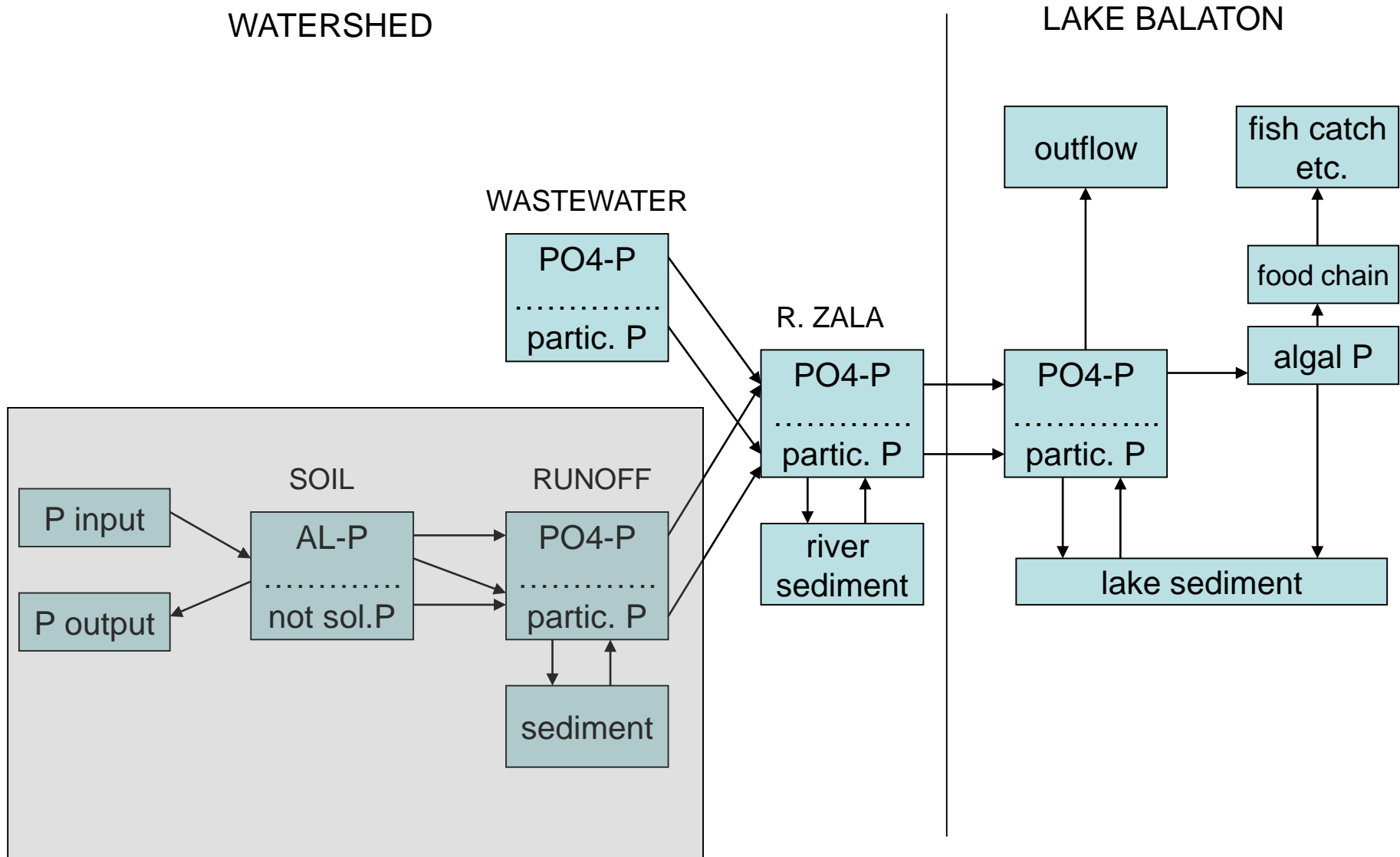

P balance and trend analysis approach

WATERSHED

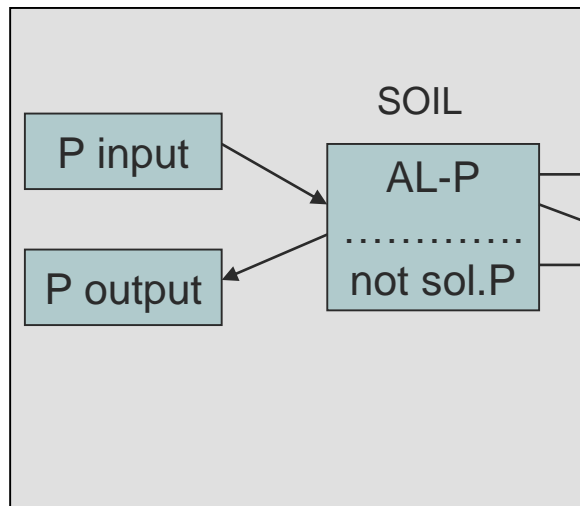

WASTEWATER

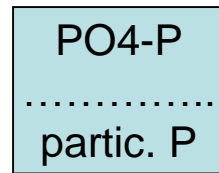

RUNOFF

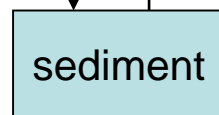
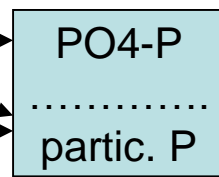

R. ZALA

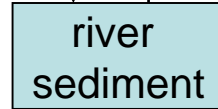
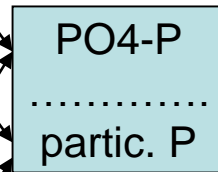

LAKE BALATON

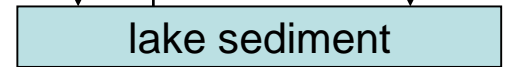
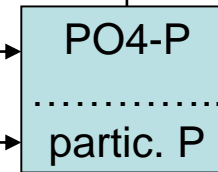
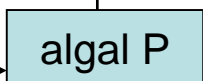
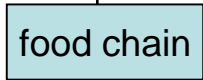
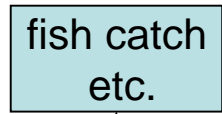
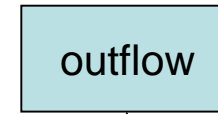

Long-term phosphorus use in Hungary calculated for the total agricultural area

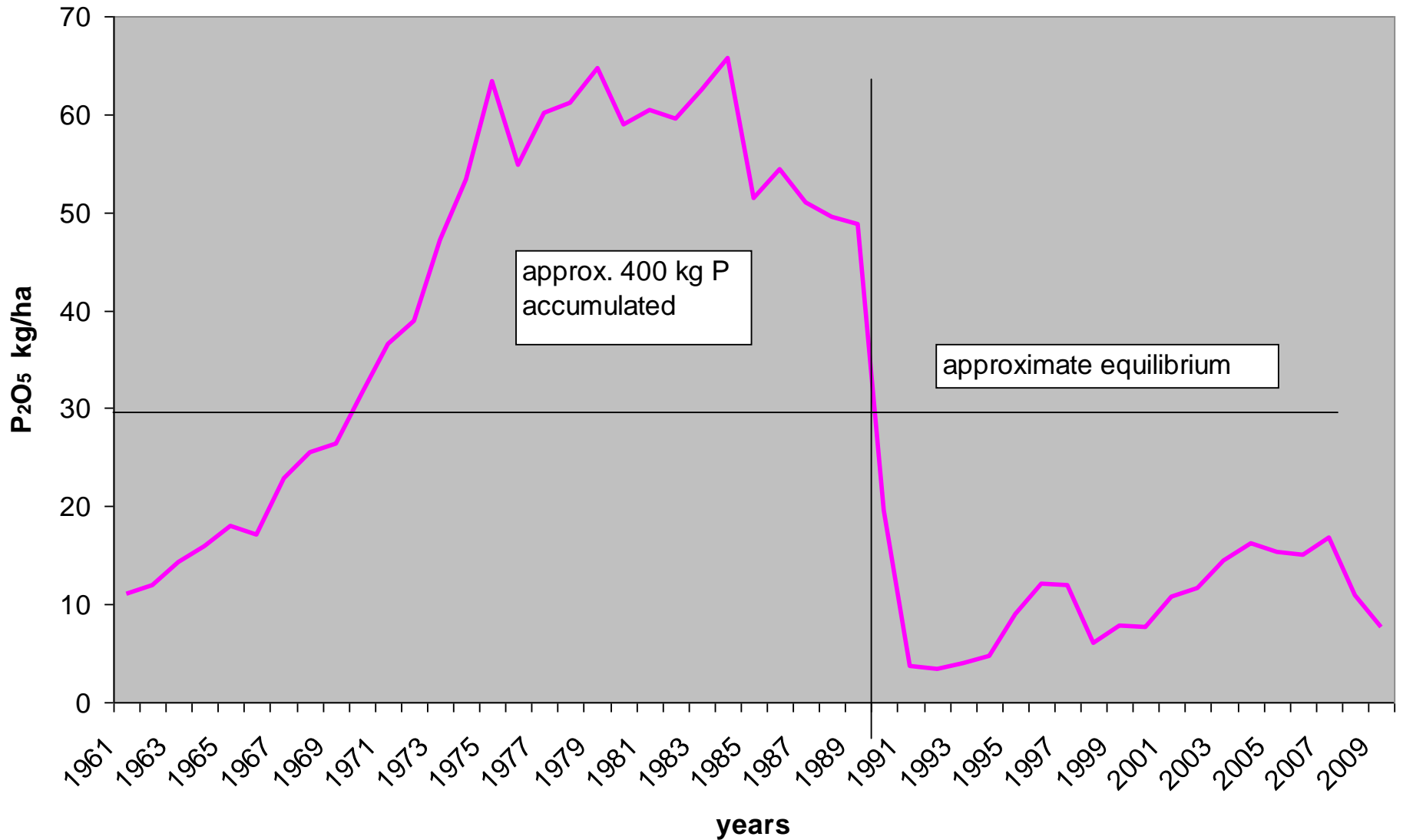

Change of soil test-P (ammonium-lactate soluble P) in arable soils in the watershed of Lake Balaton

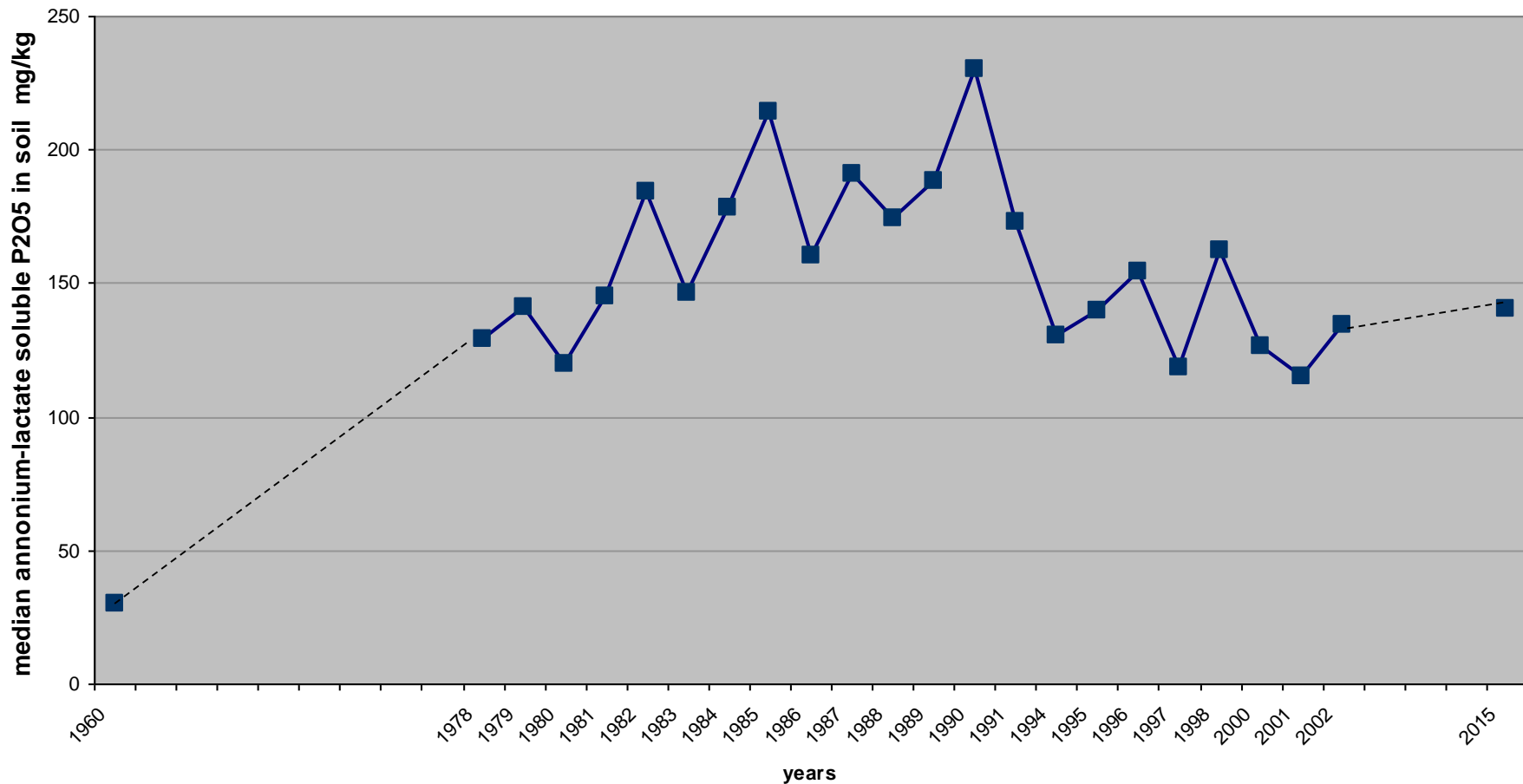

Model experiment approach

WATERSHED

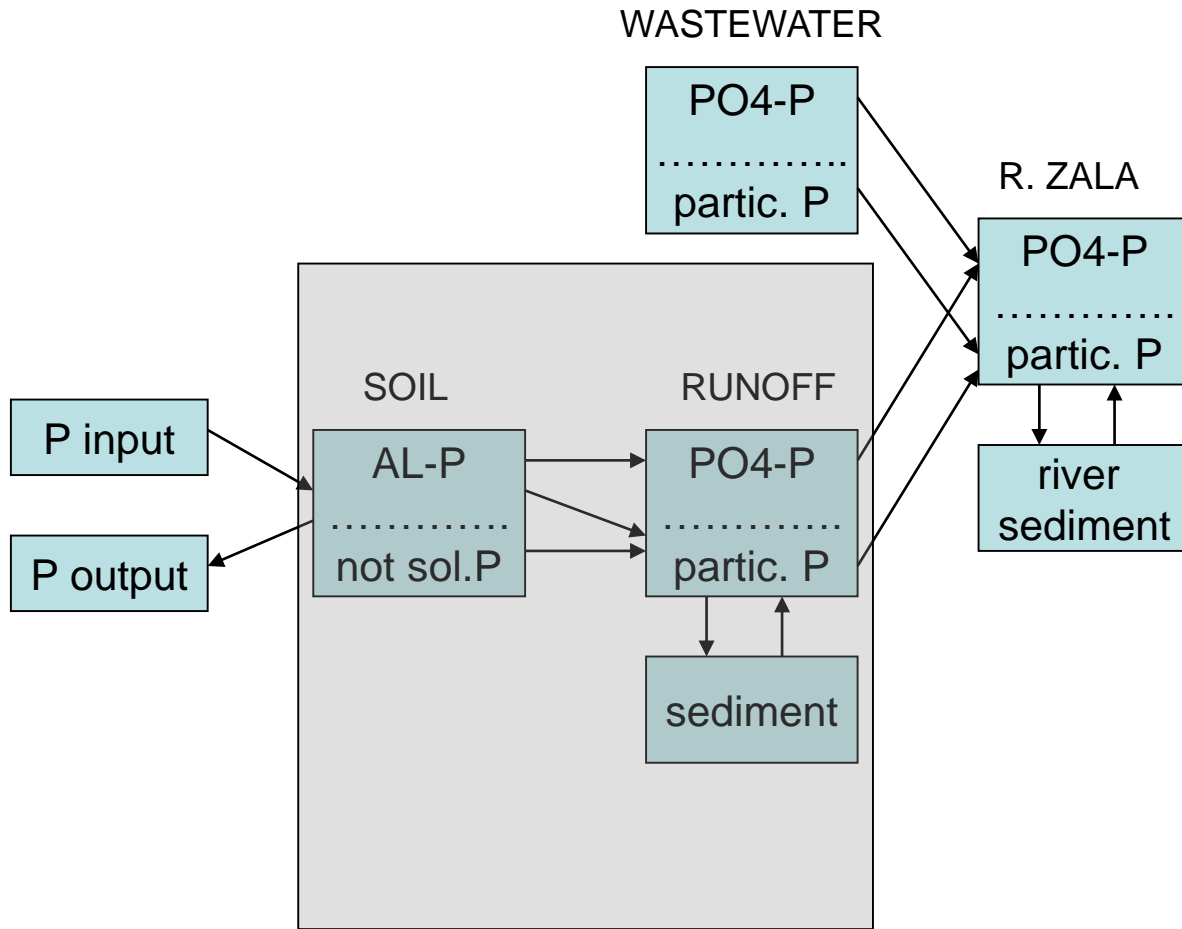

LAKE BALATON

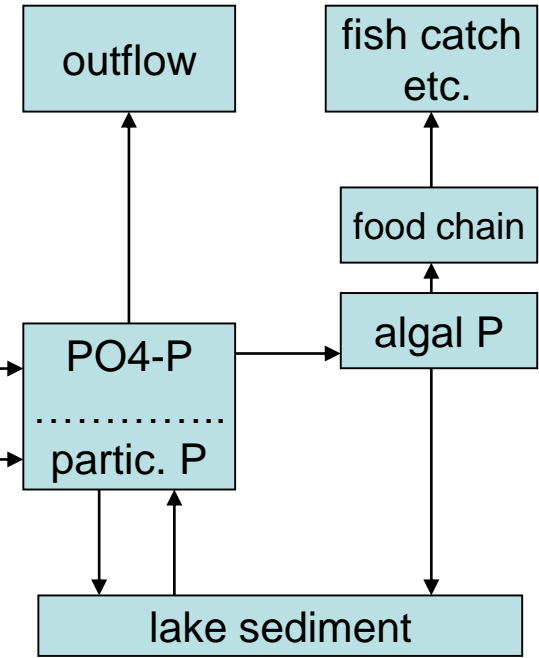

PO₄-P content in suspensions prepared from differently treated soils (0-150 kg/ha/yr P₂O₅) (average of several soil to solution ratios and deposition times) at 7 sites

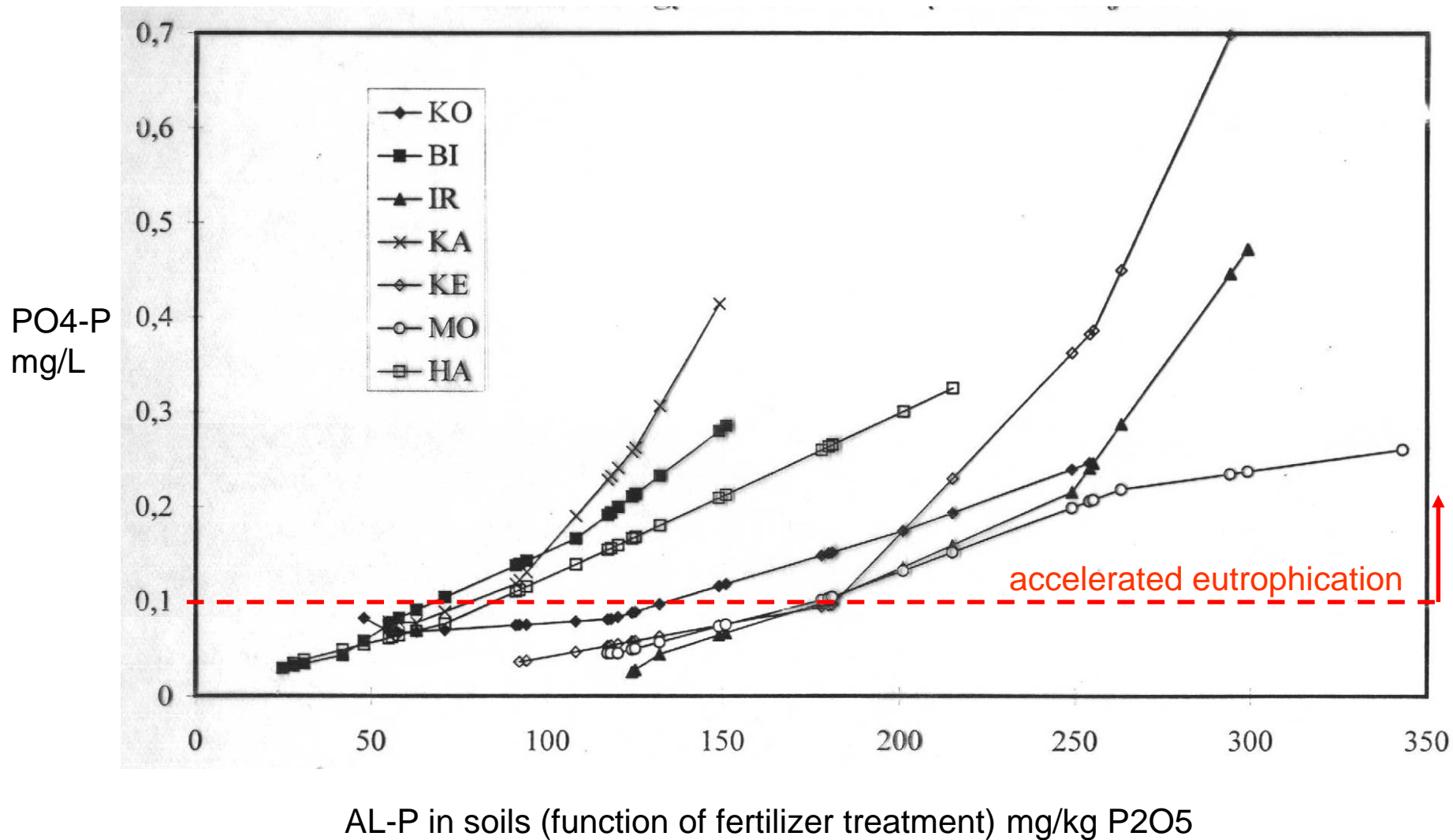

Plot scale erosion experiments in the lab and on the field

WATERSHED

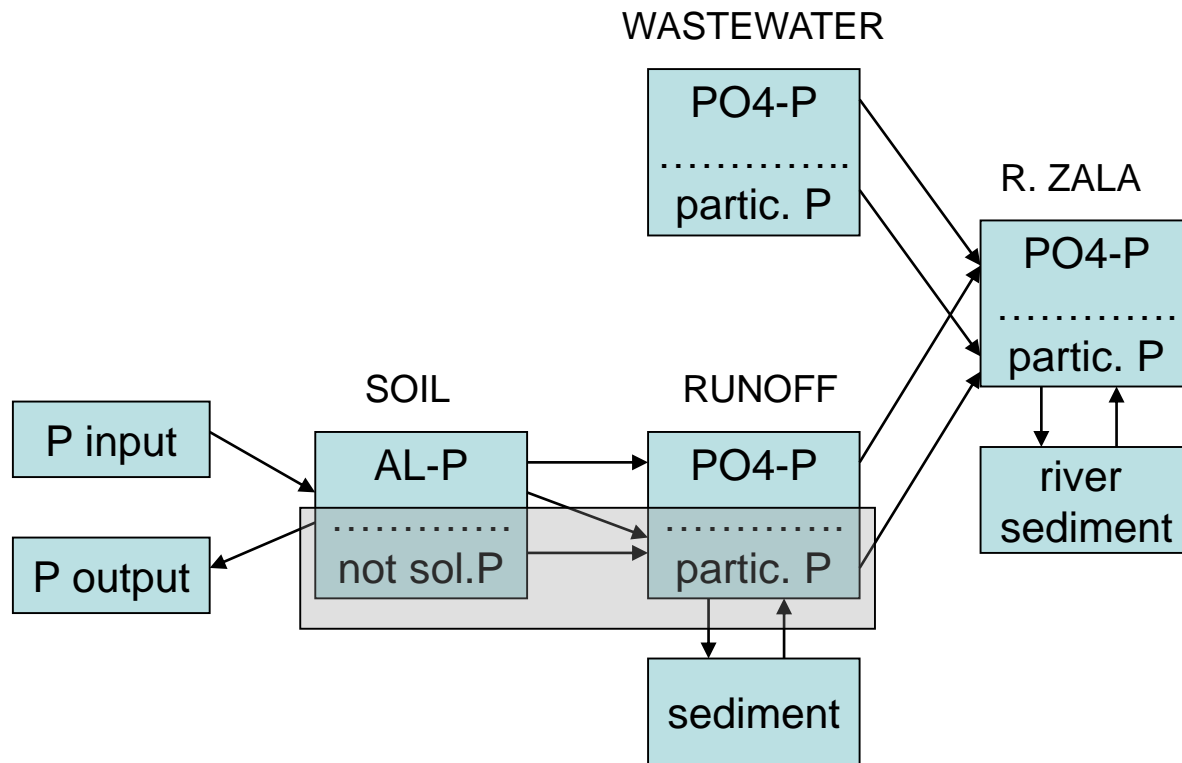

LAKE BALATON

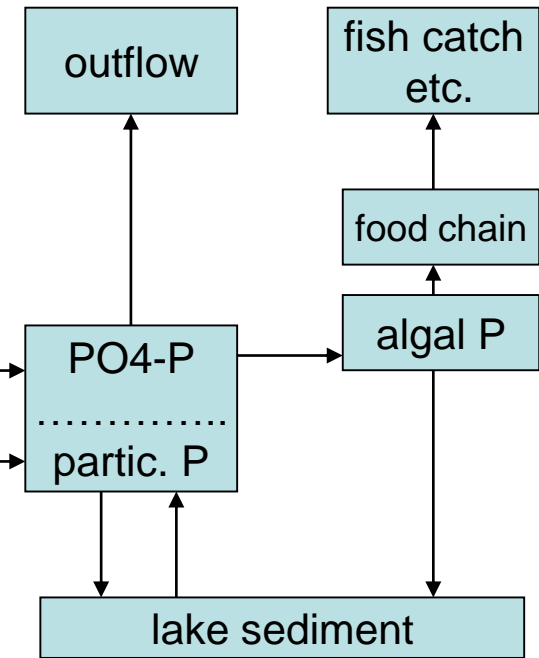

Four experimental sites (representative for the watershed)

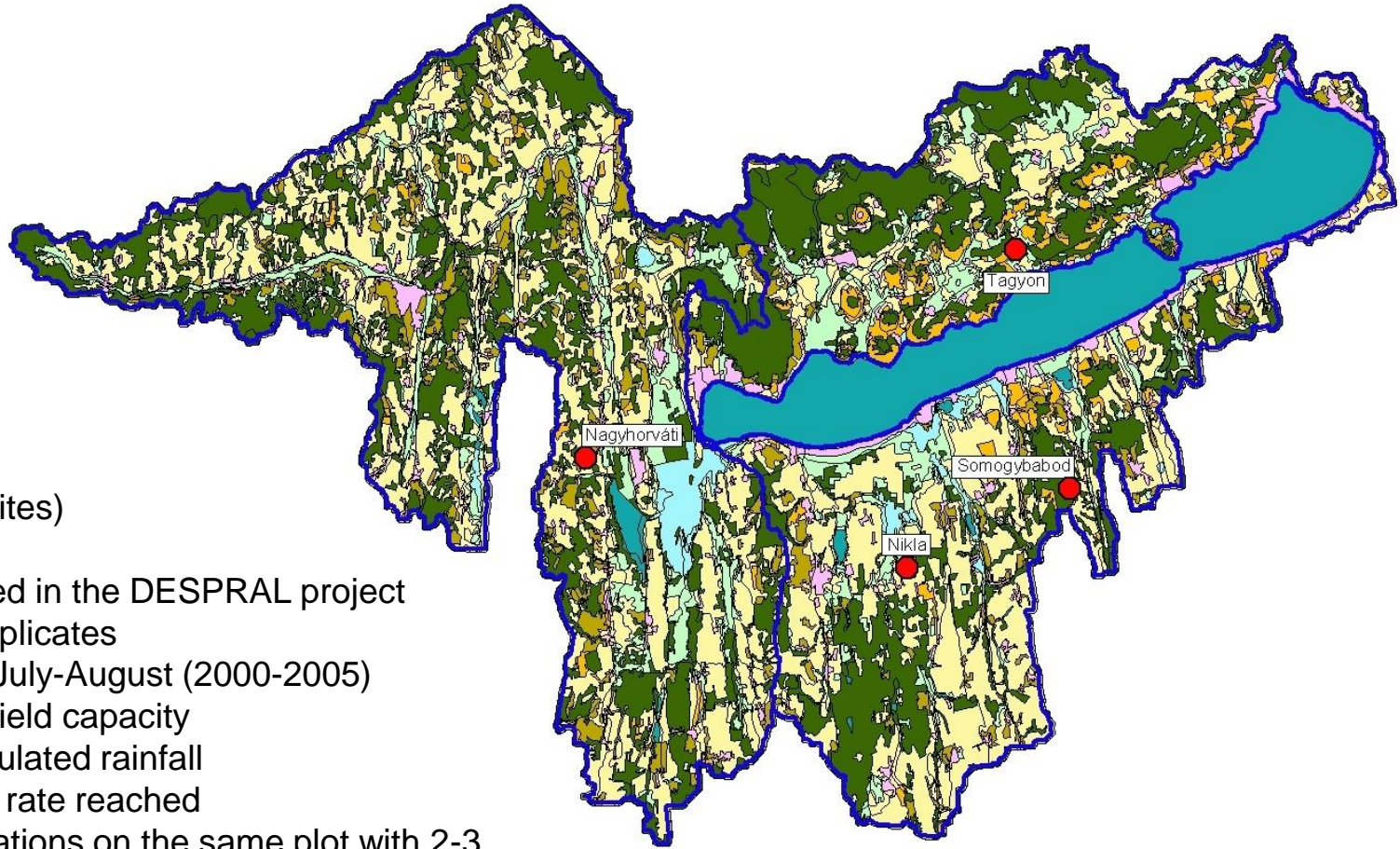

Field experiments (4 sites)

Methodology developed in the DESPRAL project
 2x5 m plot size, 3-4 replicates
 Seedbed condition in July-August (2000-2005)
 Gentle pre-wetting to field capacity
 60 (90-120) mm/h simulated rainfall
 until equilibrium runoff rate reached
 3-4 consecutive simulations on the same plot with 2-3
 day return time

Laboratory experiments (3 sites)

1x3x0.5 m big boxes, 2 replicates (2006)
 Field-equivalent slope + 13 %
 ...other conditions are the same

Sites	pH _{dw}	pH _{CaCl2}	OM %	CaCO ₃ %	sand %	silt %	clay %
Nagyhorváti(1)	7.3	6.8	1.71	0.4	35.6	41.6	22.8
Somogybabod(2)	8.3	7.7	1.52	22	31.4	51.7	16.9
Tagyon(3)	7.6	7.2	1.81	4.3	41.3	29.5	29.2
Nikla(4)	5.8	5.4	1.20	0	82.1	13.7	4.2

Plot scale field studies



Small plot (2*5 m) measurements on the field; 60(-120) mm/h until stady-state runoff

Large laboratory studies



1*3*0.5 m; 25 cm arable soil + 25 cm sand (subsoil)

Erosion rates with the variability at the four sites interpolated to round minutes

Erózió NAGYHORVÁTI

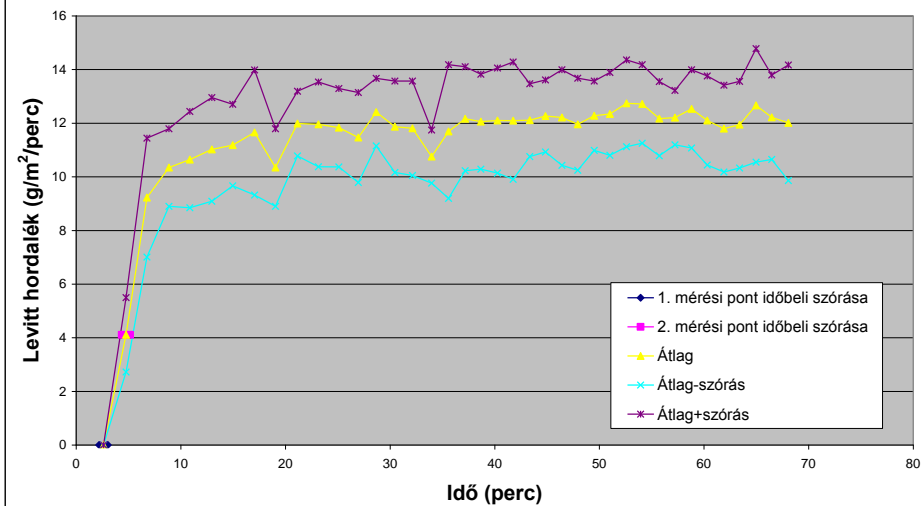

Erózió TAGYON

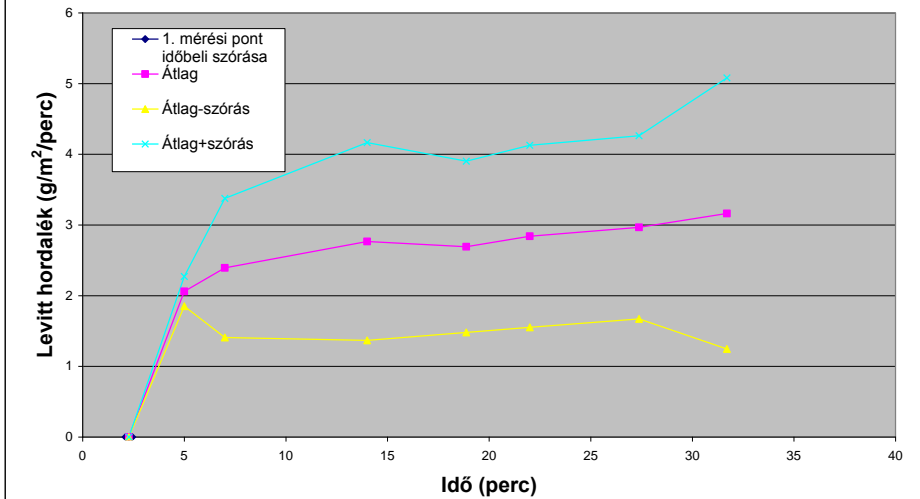

Erózió SOMOGYBABOD

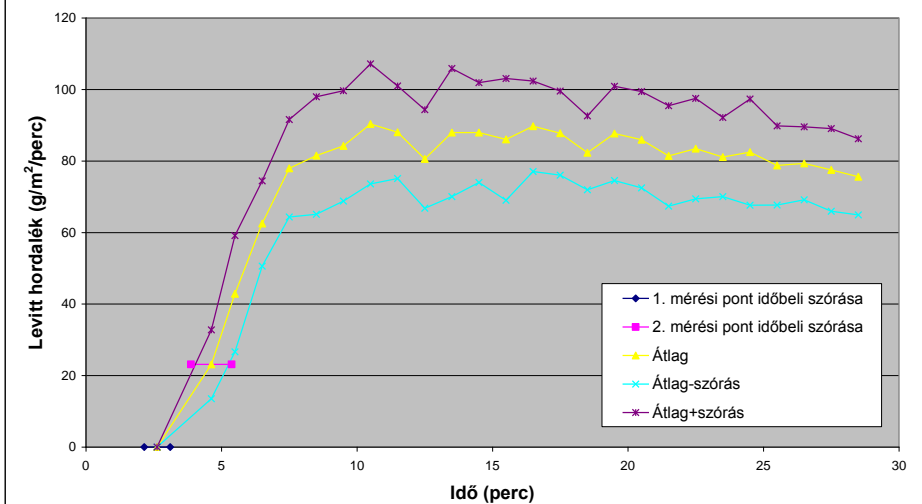

Erózió NIKLA

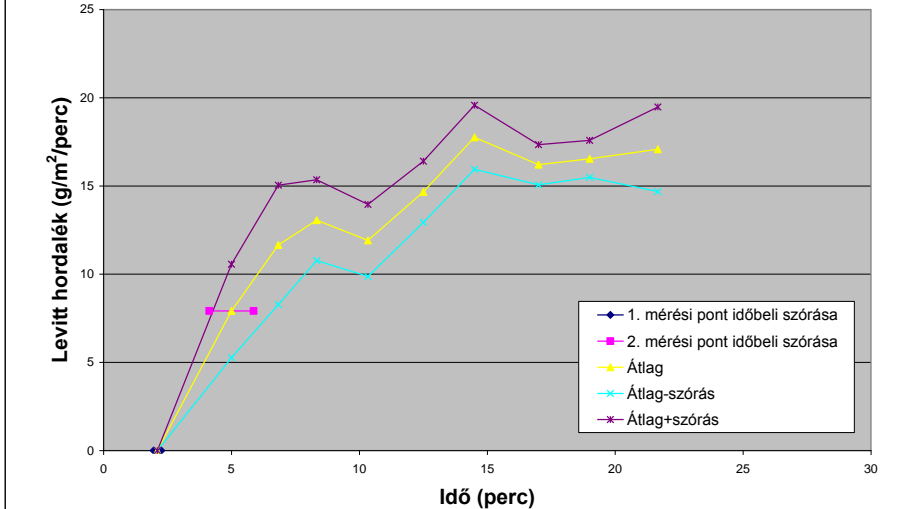



Nagyhorváti

Somogybabod

Tagyon



Re-analysis of the data

Technical objectives

- 1.) What is the gain from using physically based model instead of empirical (USLE)
- 2.) How can we use the experimental results to parameterize models
- 3.) How far can we extend capabilities of empirical models by the results
- 4.) What is the key variable that should be monitored to improve erosion prediction

Re-analysed data

Results of the field experiments (4 sites)

erosion g/m²/min

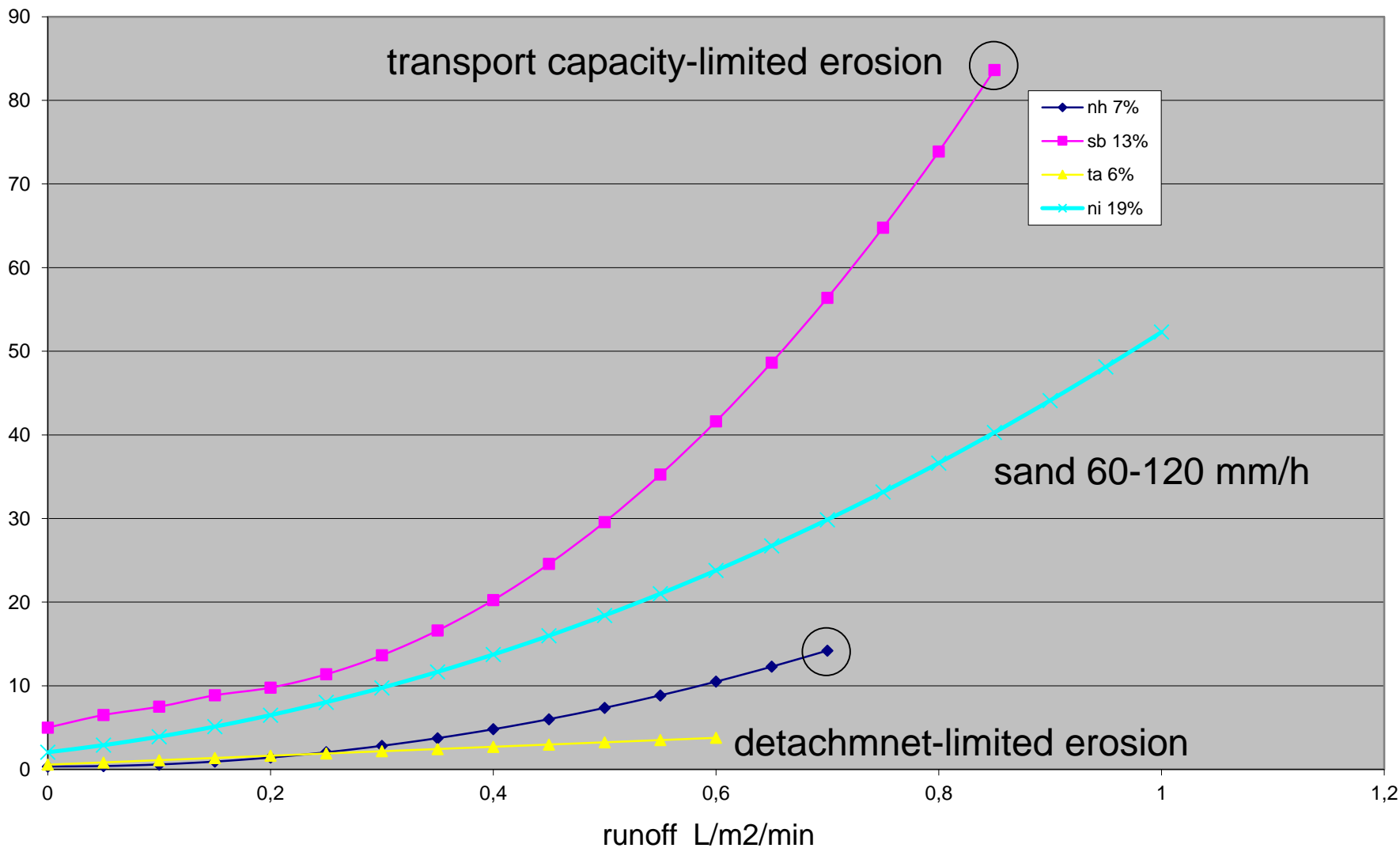

Re-analysed data

Results os the laboratory experiments (3 sites)

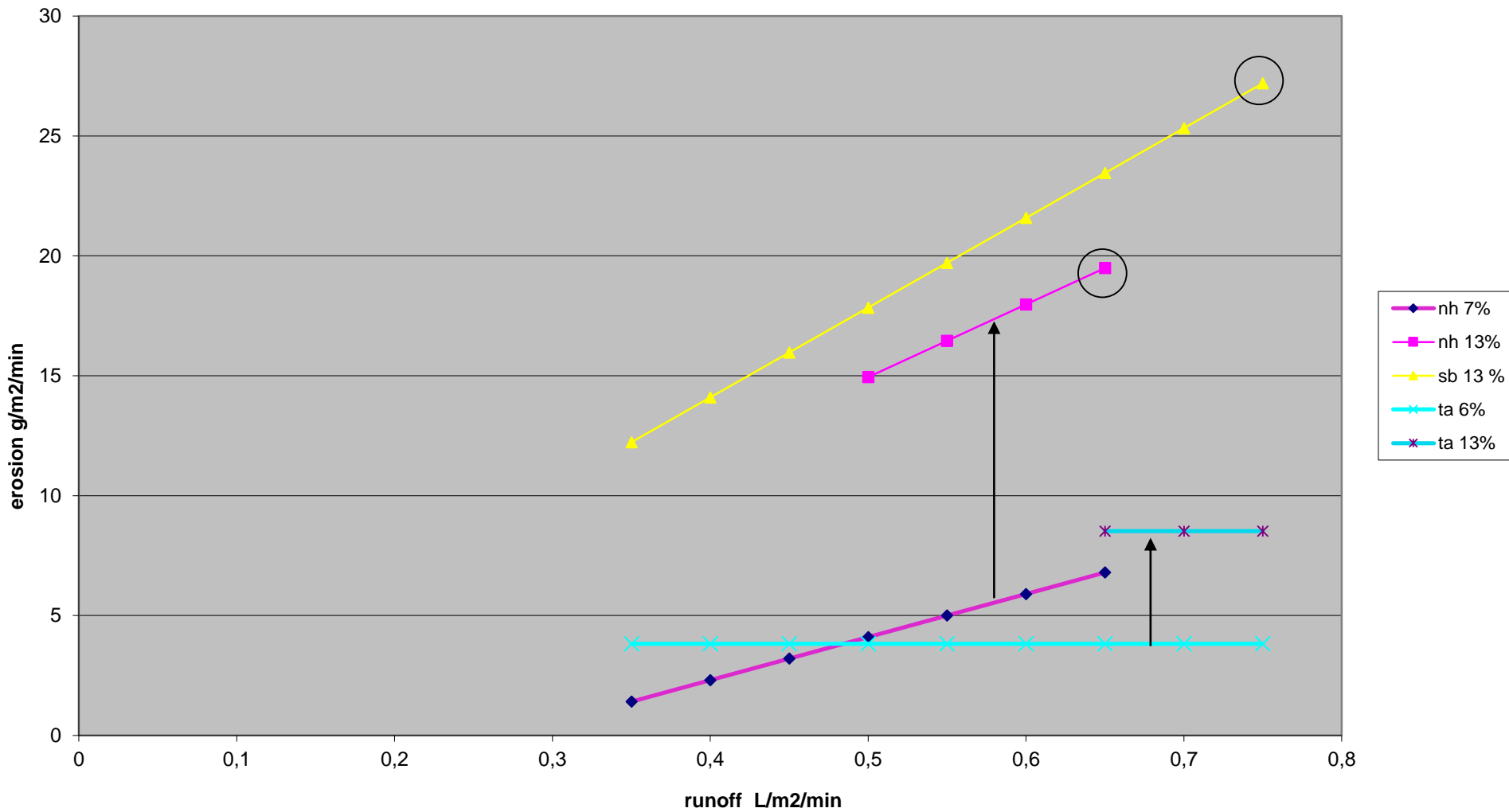

Re-analysed data

plot No	Site	experiment	slope %	n	LN_runoff	LN_erosion	slope of the	r2_of the
					mean	mean	linear equation	linear equation
11	Nagyhorváti(1)	field	7	122	-0.884	1.636	1.466	0.931
12	Nagyhorváti(1)	field	7	103	-0.881	1.920	1.716	0.943
13	Nagyhorváti(1)	field	7	146	-0.900	1.734	1.568	0.974
14	Nagyhorváti(1)	field	7	125	-0.855	1.410	1.684	0.828
15	Nagyhorváti(1)	laboratory	7	29	-0.625	1.517	3.022	0.895
16	Nagyhorváti(1)	laboratory	13	22	-0.592	2.664	1.006	0.178
21	Somogybabod(2)	field	13	85	-0.309	3.950	1.703	0.885
22	Somogybabod(2)	field	13	82	-0.357	4.140	1.436	0.803
23	Somogybabod(2)	field	13	85	-0.288	4.279	1.643	0.776
24	Somogybabod(2)	field	13	82	-0.273	4.170	1.799	0.539
25	Somogybabod(2)	laboratory	13	29	-0.554	2.998	1.130	0.532
31	Tagyon(3)	field	6	85	-0.918	0.888	0.941	0.817
32	Tagyon(3)	field	6	90	-0.868	1.316	0.255	0.170
33	Tagyon(3)	field	6	76	-0.818	0.775	1.017	0.695
35	Tagyon(3)	laboratory	6	31	-0.567	1.328	-0.019	0.000
36	Tagyon(3)	laboratory	13	36	-0.331	2.135	1.562	0.320
41	Nikla(4)	field	19	40	-0.551	3.341	1.678	0.829
42	Nikla(4)	field	19	37	-0.737	3.067	1.539	0.774
43	Nikla(4)	field	19	29	-0.482	2.892	1.793	0.560

		R ²
Linear regression	ln(runoff) → ln(erosion) :	0.62
ANOVA	everything else than runoff (main effects)	0.80
ANOVA	(nested designs)	0.84
GLM	(main effects + runoff as covariance factor)	0.96

Conclusions

1.) What is the gain from using physically based model instead of empirical (USLE)

Relatively small

2.) How can we use the experimental results to parameterize models

They cover the whole range of soil variability within this watershed

3.) How far can we extend capabilities of empirical models by the results

Empirical runoff dependence functions of erosion can be added

4.) What is the key variable that should be monitored to improve erosion prediction

Subsoil permeability

Hot spots: loess derived arable soils

These areas produce more than 2/3 of the primary particulate P loss (erosion)

Reduction of erosion rate (subsoil loosening, mulching) may have dramatic decrease in diffuse phosphorus load to Lake Balaton

